

Product Data Sheet

QuikSwap Quick Change System for Air Plasma Spray Guns

Gun changeover in a plasma spray booth is not the most demanding task, but when done frequently, the time adds up and productivity goes down. QuikSwap™ saves time and improves productivity. It is the perfect solution whether changing guns in the same spray booth or moving spray guns between spray booths.

1 General Description

QuikSwap reduces the time required for plasma gun changeover to seconds. It's a simple solution that is ideal for:

- Operations that frequently change spray guns within a single spray booth
- Operations that frequently move spray guns between multiple spray booths
- Mass production operations that need rapid gun changeover for gun maintenance

A complete QuikSwap system consists of the QuikSwap and the QuikSwap Gun Coupling Unit. Purchase a QuikSwap system and as many additional QuikSwap Gun Coupling Units as needed. Simply attach the gun cables to QuikSwap and each of the QuikSwap Gun Coupling Units once. Afterwards, just snap off one gun and snap on another. It's that easy.

Need QuikSwap for multiple spray booths? Purchase several complete QuikSwap systems and additional QuikSwap Gun Coupling Units, if required.

The QuikSwap benefit: Simple handling for all single cathode plasma spray guns!

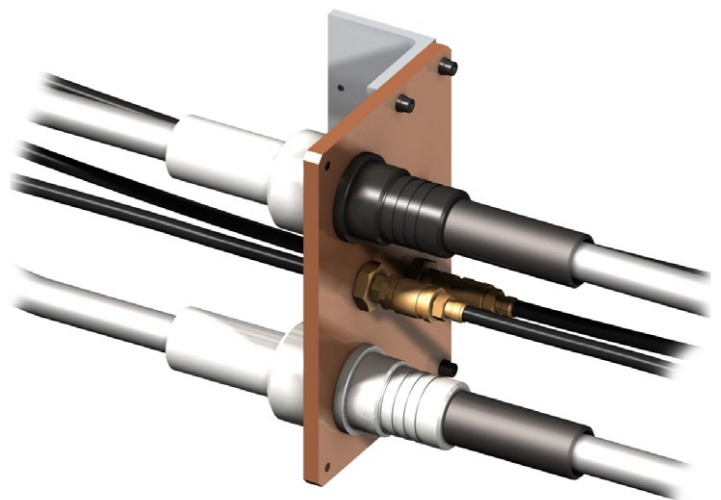

QuikSwap

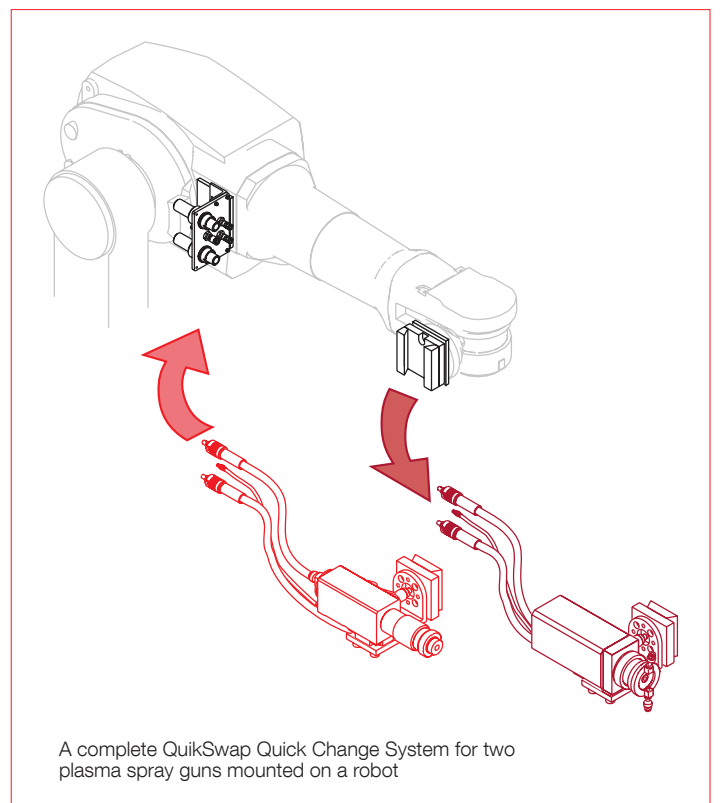

2 QuikSwap Product Structure

2.1 Overview

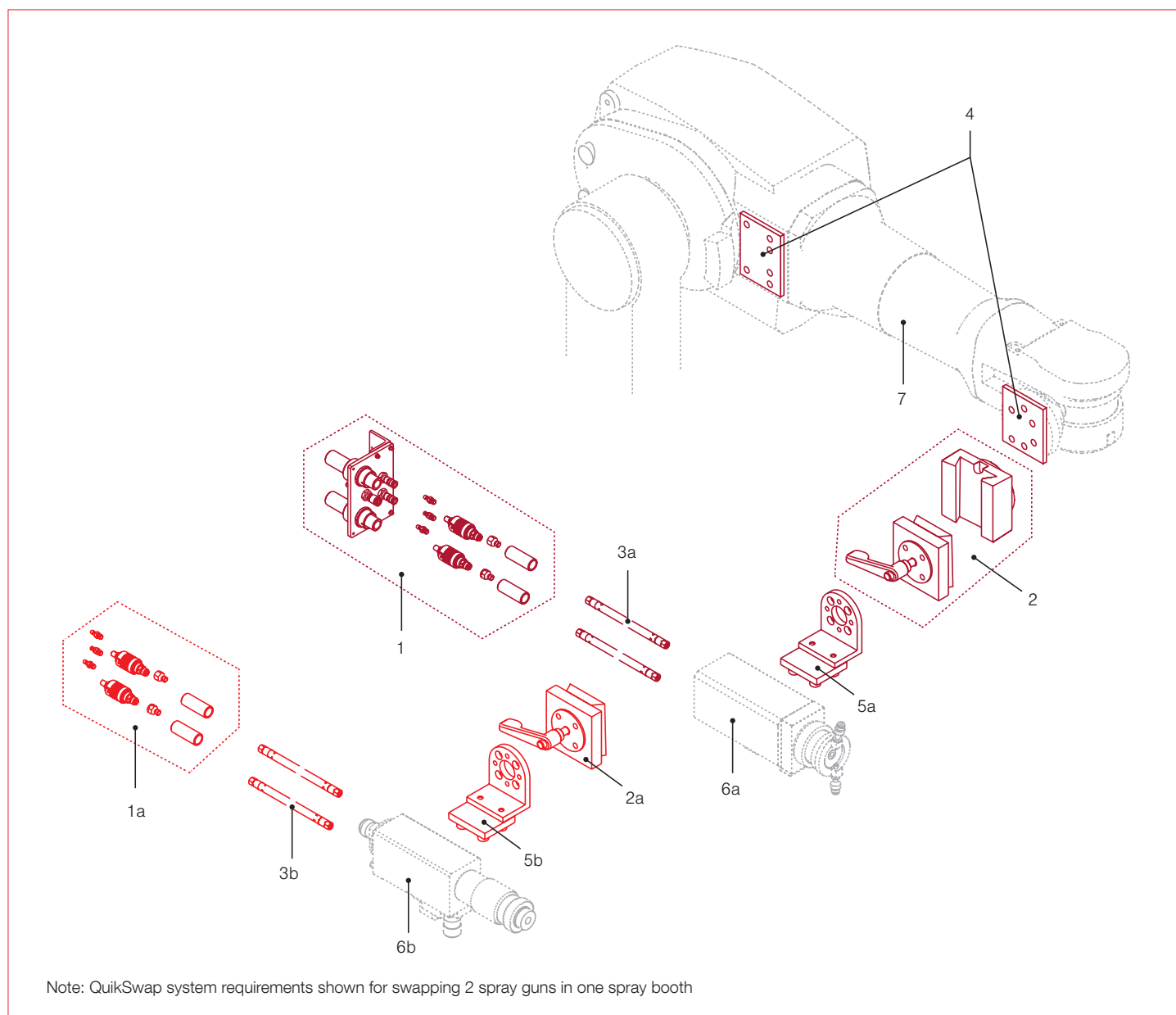









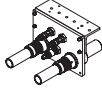

Complete QuikSwap System (1 st Spray Gun)		Gun Adapter Units for Additional Guns	
1	QuikSwap	1a ^a	QuikSwap Hose and Cable Connectors
2	QuikSwap Gun Coupling Unit	2a ^a	QuikSwap Gun Coupling Connector
3a	QuikSwap Hose and Cable Set	3b	QuikSwap Hose and Cable Set
4	Set of Robot Mounting Plates		
5a ^c	Gun Mounting Bracket	5b ^c	Gun Mounting Bracket
6a ^b	Spray Gun	6b ^b	Spray Gun
7 ^b	Robot		

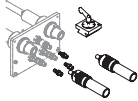
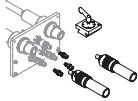
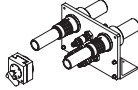

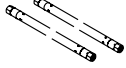





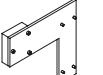
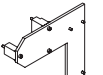

^a Included in QuikSwap Connector Kit (see Section 2.2)

^b Shown for illustration purposes only; not included with QuikSwap Quick Change System

^c Specify gun and robot used; bracket shown here is for illustration purposes and actual configuration will vary depending on the spray gun; see Section 2.2.

2.2 Order Details – QuikSwap System / Kits ^a

Description	Order No.	Kit Order No.
QuikSwap Components - 1st Spray Gun		
QuikSwap Complete System Components		
 QuikSwap (includes hose and cable connectors in the QuikSwap Connector Kit)	1072915	
 Gun connection piece, Quick Coupler	1011389	1076693
 Robot connection piece, Quick Coupler	1011380	
 Changeover adapter for Metco-style hoses, UNF 9/15-18		1097618
 Changeover adapter for PT-style hoses, UNF 9/16-20		1076694
 Quick Coupler Quick Swap Kit		1076693
Gun Mounting Bracket ^a		
 F4-MB to ABB Robot		1004242
 F4MB90-XL to ABB Robot		1084040
QuikSwap Hose and Cable Set (specify spray gun model) ^b		
 8MH hose and cable set: 1.5 m (5 ft)		1058504
8MH hose and cable set: 3.5 m (11.5 ft)		1058503
8MH hose and cable set: length specified by customer		1034390
Plasma gas hose: 1.5 m (5 ft)	1008184	
Plasma gas hose: 3.0 m (10 ft)	1037324	
Plasma gas hose: 3.5 m (11.5 ft)	1008188	
Gun hose +/- set: 1.5 m (5 ft)		1008174
Gun hose +/- set: 2.0 m (6.5 ft)		1018776
Gun hose +/- set: 3.0 m (10 ft)		1018781
Gun hose +/- set: 3.5 m (11.5 ft)		1003101
Set of Robot Mounting Plates ^a		
 ABB IRB 2400		1076695
 ABB IRB 2600		1097513
 ABB IRB 4400		1097495
 ABB IRB 4600		1097497
 Fanuc 720i		1096566

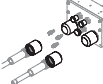
Description	Order No.	Kit Order No.
QuikSwap Components - 1st Spray Gun (continued)		
Robot Body Adapter ^a		
	ABB IRB 4600	1082796
	ABB IRB 2400	1096983
	ABB IRB 4400 L	1077524
Robot Wrist Spray Gun Adapter ^a		
	ABB IRB 1600, ABB IRB 2400	1004252
	ABB IRB 4400	1011394
	Fanuc M710	1096567
QuikSwap Components for Additional Spray Guns		
	Water/power left-hand (-) male connector	1072896
	Water/power right-hand (+) male connector	1072810
	PT-style air hose quick coupling, 9/16-20 UNF to d11 Swagelok	1072901
	Metco-style air hose quick coupling, 9/16-18 UNF to d11 Swagelok	1097022
	PT-style air hose quick coupling, 9/16-20 UNF to d11-IV Swagelok	1073015
	Metco-style air hose quick coupling, 9/16-18 UNF to d11-IV Swagelok	1097021
	Cap protection set	1096614

^a Kits for other robot models available on request; gun model must be specified; please contact Oerlikon Metco System Sales for more information

^b Other lengths on request

3 Technical Data

3.1 Dimensions

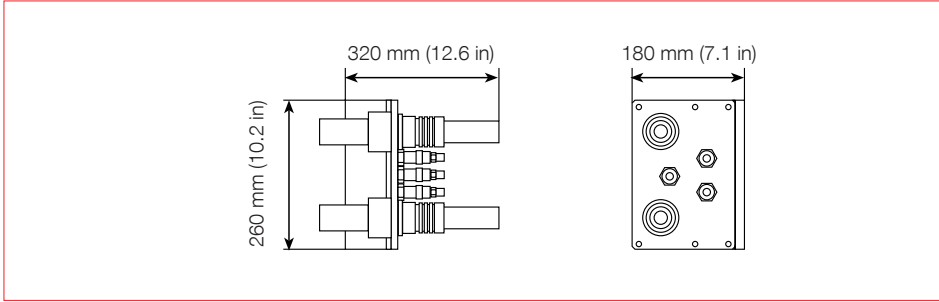

3.2 Specifications

QuikSwap Quick Change System

Weight	6 kg	13.2 lb
--------	------	---------

Water / Power Connectors

Water Connection		
------------------	--	--

Diameter	8 mm	0.31 in
Max. Operating Pressure	20 bar	290 psi
Residual Leakage During Disconnection	0.026 cm ³	0.01 in ³

Power Transmission		
--------------------	--	--

Contact Resistance	10 μΩ	
Nominal Current max.	1000 A	

Coupling		
----------	--	--

Extraction Force	80 N	18 lbf
Insertion Force	120 N	27 lbf

Environment

Temperature	+0 to +100 °C	+32 to +212 °F
Humidity	< 75 %, non-condensing	

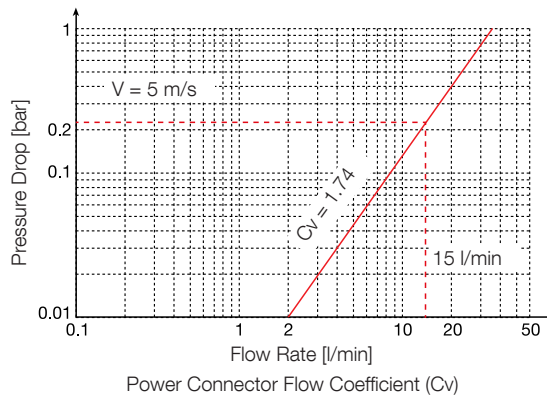

Information is subject to change without prior notice.